

**AIPMT – 2015**  
**(Physics, Chemistry and Biology)**  
**Code – E**  
**Answer Key and Solution**

---

**Answer Key**

1	(3)	2	(2)	3	(2)	4	(2)	5	(3)	6	(3)	7	(1)	8	(1)	9	(3)	10	(4)
11	(3)	12	(4)	13	(2)	14	(3)	15	(2)	16	(3)	17	(4)	18	(4)	19	(3)	20	(3)
21	(2)	22	(3)	23	(3)	24	(2)	25	(3)	26	(4)	27	(3)	28	(1)	29	(1)	30	(2)
31	(3)	32	(4)	33	(4)	34	(1)	35	(2)	36	(3)	37	(1)	38	(1)	39	(2)	40	(2)
41	(2)	42	(2)	43	(2)	44	(4)	45	(3)	46	(2)	47	(3)	48	(3)	49	(3)	50	(1)
51	(3)	52	(3)	53	(4)	54	(2)	55	(4)	56	(3)	57	(1)	58	(1)	59	(4)	60	(3)
61	(2)	62	(2)	63	(2)	64	(2)	65	(3)	66	(1)	67	(1)	68	(4)	69	(2)	70	(4)
71	(1)	72	(4)	73	(4)	74	(3)	75	(4)	76	(1)	77	(3)	78	(3)	79	(1)	80	(1)
81	(1)	82	(1)	83	(3)	84	(3)	85	(1)	86	(4)	87	(2)	88	(1)	89	(2)	90	(3)
91	(2)	92	(3)	93	(4)	94	(4)	95	(3)	96	(3)	97	(2)	98	(3)	99	(3)	100	(2)
101	(4)	102	(1)	103	(2)	104	(2)	105	(2)	106	(1)	107	(4)	108	(2)	109	(1)	110	(4)
111	(2)	112	(1)	113	(2)	114	(1)	115	(1)	116	(4)	117	(2)	118	(1)	119	(2)	120	(4)
121	(4)	122	(2)	123	(3)	124	(3)	125	(3)	126	(1)	127	(4)	128	(2)	129	(2)	130	(2)
131	(2)	132	(1)	133	(2)	134	(4)	135	(2)	136	(3)	137	(3)	138	(2)	139	(3)	140	(2)
141	(3)	142	(4)	143	(3)	144	(4)	145	(2)	146	(3)	147	(1)	148	(3)	149	(2)	150	(3)
151	(4)	152	(1)	153	(3)	154	(4)	155	(2)	156	(2)	157	(3)	158	(3)	159	(1)	160	(4)
161	(3)	162	(3)	163	(1)	164	(4)	165	(2)	166	(3)	167	(3)	168	(2)	169	(3)	170	(4)
171	(1)	172	(3)	173	(3)	174	(1)	175	(2)	176	(4)	177	(2)	178	(2)	179	(1)	180	(4)

## Physics

### 1. [E V<sup>-2</sup> T<sup>-2</sup>]

Consider  $\sigma$  to be the surface tension and its fundamental quantities are given as

$$\sigma = E^a V^b T^c$$

Equating the dimensions on both sides of the equation, we get

$$\frac{M^1 L^1 T^{-2}}{L} = (M^1 L^2 T^{-2})^a \left( \frac{L}{T} \right)^b (T)^c$$

$$M^1 L^0 T^{-2} = M^a L^{2a+b} T^{-2a-b+c}$$

$$\therefore a = 1, -2a - b + c =$$

$$-2 \quad 2a + b = 0$$

$$\therefore b = -2$$

$$\text{and } -2 \times 1 - (-2) + c = -2$$

$$c = -2$$

Hence, the dimensional formula of surface tension will be [E V<sup>-2</sup> T<sup>-2</sup>].

### 2. 5 h

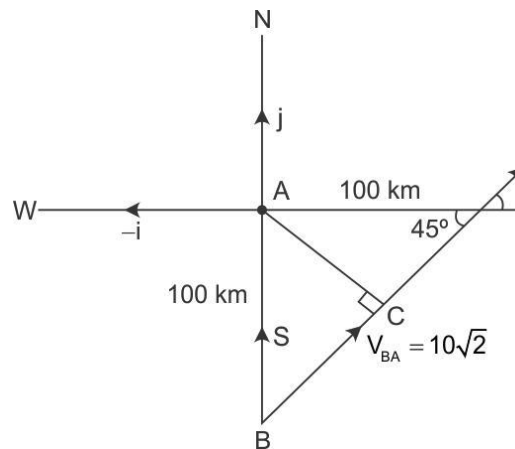

From the above figure, we see that

Ship A is moving westwards with speed of 10 km/h

Speed of ship A,  $\vec{v}_A = 10(-\hat{i})$

Ship B is moving northwards with speed of 10 km/h

Speed of ship B,  $\vec{v}_B = 10(\hat{j})$

Relative speed of ship B w.r.t. speed of ship A is given as

$$\vec{v}_{BA} = 10\hat{j} + 10(-\hat{i})$$

$$\therefore v_{BA} = \sqrt{10^2 + 10^2} = 10\sqrt{2}$$

$$\text{Distance } BC = 100 \cos 45^\circ = 50\sqrt{2}$$

Because ship B is 100 km south of A, the time after which the distance between them becomes shortest is

$$t = \frac{50\sqrt{10}\sqrt{2}}{2} = 5 \text{ h}$$

The time after which the distance between them becomes shortest is 5 h.

3.  $-2n\beta^2x^{-4n-1}$

A particle of unit mass undergoes one-dimensional motion such that its velocity varies according to the equation  $v(x) = \beta x^{-2n}$  ..... (1)

where  $b$  and  $n$  are constants and  $x$  is the position of the particle.

Differentiating equation (i) w.r.t.  $x$ , we get acceleration of particle as

$$a = v \frac{dv(x)}{dx} = \beta x^{-2n} (\beta(-2n)x^{-2n-1})$$

$$a = -2n\beta^2 x^{-4n-1}$$

4. 6 N

$$F_{\text{net}} = M_{\text{total}} \times \text{acceleration}$$

$$\therefore \text{acceleration, } a = \frac{F_{\text{net}}}{M_{\text{total}}} = \frac{14}{4 + 2 + 1} = 2 \text{ m/s}^2$$

Because a force of 14 N is applied on the 4 kg block, the contact force between A and B will move the 2 kg and 1 kg block with the same acceleration.  $F = (2 + 1) \times a = 3 \times 2 = 6 \text{ N}$

5.  $\frac{m_1 m_2 (1 + \mu_k) g}{m_1 + m_2}$

Mass of the block A, =  $m_1$   
 Mass of the block B, =  $m_2$

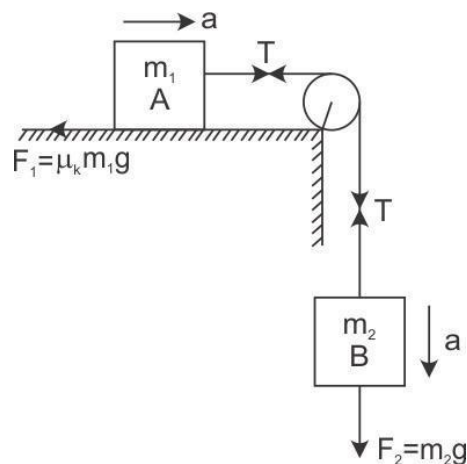

From the figure, we get

$$m_2 g - T = m_2 a \quad (i)$$

$$T - \mu_k m_1 g = m_1 a \quad (ii)$$

from (i) and (ii)

$$a = \frac{(m_2 - \mu_k m_1)g}{m_1 + m_2}$$

For the mass of block  $m_2$

$$m_2 g - T = m_2 \frac{(m_2 - \mu_k m_1)g}{m_1 + m_2}$$

$$T = m_2 g - \frac{m_2 (m_2 - \mu_k m_1)g}{m_1 + m_2} = m_2 g \left[ 1 - \frac{m_2 - \mu_k m_1}{m_1 + m_2} \right]$$

$$T = \frac{m_1 m_2 (1 + \mu_k)g}{m_1 + m_2}$$

6.  $W_P > W_Q$  ;  $W_Q > W_P$

It is given that the spring constants are related as  $K_P > K_Q$

Case (a): When stretched by the same amount

$$x_1 = x_2 = x$$

$$W_P = \frac{1}{2} K_P x^2 = K_P x^2$$

$$W_Q = \frac{1}{2} K_Q x^2 = K_Q x^2$$

$$\Rightarrow W_P > W_Q$$

Case (b): When stretched by the same force

$$F_1 = F_2 = F$$

$$W = \frac{F^2}{2K}$$

$$\Rightarrow \frac{W_P}{W_Q} = \frac{K_Q}{K_P}$$

$$\therefore W_Q > W_P$$

7. 475 J

Mass of block is  $m = 10 \text{ kg}$

Speed of block is  $v = 10 \text{ ms}^{-1}$

The retarding force on the block is  $F = 0.1x \text{ J/m}$ .

We know that the work done by a variable force is given as

$$W = -\int_{x_1}^{x_2} F dx$$

Hence, we get

$$W = -\int_{20}^{30} 0.1x dx$$

$$= -0.1 \left[ \frac{x^2}{2} \right]_{20}^{30}$$

$$= -0.05 (30^2 - 20^2)$$

$$= -0.05 (900 - 400)$$

$$= -25 \text{ J}$$

Now, according to the work-energy theorem, we have

$$W = \Delta \text{K.E.} = \text{K.E.}_{\text{final}} - \text{K.E.}_{\text{initial}}$$

$$W = \text{K.E.}_{\text{final}} - \frac{1}{2}mv^2$$

$$\therefore \text{K.E.}_{\text{final}} = W + \frac{1}{2}mv^2$$

Substituting the values in the above equation, we get

$$\text{K.E.}_{\text{final}} = -25 + \frac{1}{2} \times 10 \times 10^2$$

$$= -25 + 500$$

$$= 475 \text{ J}$$

$$8. \sqrt{\frac{mk}{2t^2}}$$

We know that power is the rate of work done, i.e.  $P = W/t$

Hence, work done is  $W = Pt = kt$

According to the work-energy theorem, we have

$$W = \Delta K.E.$$

$$W = \frac{1}{2}mv^2 - 0 = \frac{1}{2}mv^2$$

Hence, we get

$$\frac{1}{2}mv^2 = kt$$

$$\therefore v^2 = \frac{2kt}{m}$$

$\therefore v =$

$$\sqrt{\frac{2kt}{m}}$$

$$\frac{2kt}{m}$$

We know that power is given as product of force and velocity.

Hence, we get

$$P = Fv$$

$$\therefore F = \frac{P}{v} = \frac{k}{v}$$

$$\therefore F = k\sqrt{\frac{m}{2kt}} = \sqrt{\frac{mk}{2t}} = \sqrt{\frac{mk}{2}} \cdot \frac{1}{t}$$

$$9. \frac{1}{2}m_1 u_1^2 + \frac{1}{2}m_2 u_2^2 - \varepsilon = \frac{1}{2}m_1 v_1^2 + \frac{1}{2}m_2 v_2^2$$

In any collision, the total energy is always conserved. Hence, we have

Initial kinetic energy = Final kinetic energy + Excitation energy

$$\therefore \frac{1}{2}m_1 u_1^2 + \frac{1}{2}m_2 u_2^2 = \frac{1}{2}m_1 v_1^2 + \frac{1}{2}m_2 v_2^2 + \varepsilon$$

$$\therefore \frac{1}{2}m_1 u_1^2 + \frac{1}{2}m_2 u_2^2 - \varepsilon = \frac{1}{2}m_1 v_1^2 + \frac{1}{2}m_2 v_2^2$$

### 10. $\frac{W(d-x)}{d}$

Let  $R_A$  and  $R_B$  be the reactions at the knife edges A and B, respectively.

The moment of forces about the knife must be equal to zero for the rod to be in equilibrium in a horizontal position.

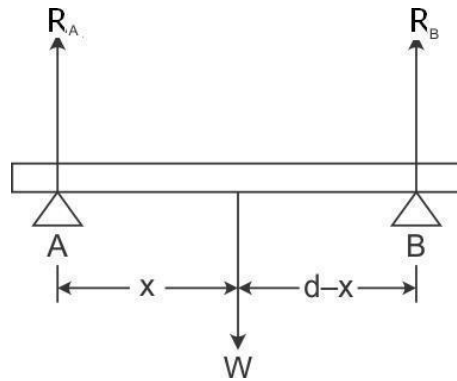

Moment of forces acting at A is given as

$$R_A \cdot 0 + xW - R_B d = 0$$

$$\text{Or, } R_B d = xW$$

$$\therefore R_B = \frac{xW}{d}$$

Moment of forces acting at B is given as

$$R_A d - (d-x)W - R_B \cdot 0 = 0$$

$$\text{Or, } R_A d = (d-x)W$$

$$\therefore R_A = \frac{W(d-x)}{d}$$

$$R_{Ad}$$

### 11. $2mv_0^2$

Because the mass moves under a central force, its angular momentum is conserved.

$$L_i = L_f$$

$$\therefore mv_0 R = mv \frac{R}{2}$$

$$\therefore v_0 = \frac{v}{2}$$

$$\therefore v = 2v_0$$

Thus, the final kinetic energy is given as

$$KE_f = \frac{1}{2} m (2v_0)^2 = 2mv_0^2$$

12.4  $mr^2$

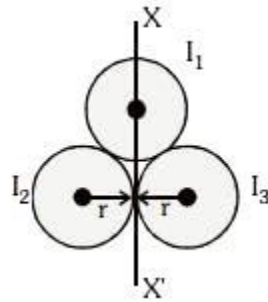

Moment of inertia of a spherical shell of radius  $r$  and mass  $m$  about its diameter is given as

$$I_{\text{diameter}} = \frac{2}{3}mr^2$$

$$\text{Thus, } I_1 = \frac{2}{3}mr^2$$

Moment of inertia of a spherical shell of radius  $R$  and mass  $m$  about a tangential axis is given as

$$I_{\text{tangential}} = \frac{2}{3}mr^2 + mr^2 = \frac{5}{3}mr^2$$

$$\text{Thus, } I_2 = I_3 = \frac{5}{3}mr^2$$

$$\text{So, } I_{\text{total}} = I_1 + I_2 + I_3$$

$$= \frac{2}{3}mr^2 + \frac{5}{3}mr^2 + \frac{5}{3}mr^2$$

$$= 4mr^2$$

$$\text{Thus, } I_{XX'} = 4mr^2$$



13.  $GMK = 4\pi^2$

Orbital speed of a satellite is given as

$$v = \sqrt{\frac{GM}{r}}$$

The time period of the satellite is given as

$$T = \frac{2\pi r}{v} = \frac{2\pi r \sqrt{r}}{\sqrt{GM}}$$

$$\Rightarrow T = \frac{2\pi r^{3/2}}{\sqrt{GM}}$$

Squaring both the sides, we get

$$T^2 = \frac{4\pi^2 r^3}{GM}$$

Comparing with  $T^2 = Kr^3$ , we get

$$K = \frac{4\pi^2}{GM}$$

$$\Rightarrow GMK = 4\pi^2$$

14.7.5R

Initially, the distance between the centres of the two spherical bodies is  $12R$ .

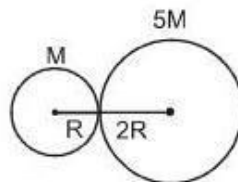

The distance between their centres at the time of collision is  $3R$ .

So, the total distance travelled by the two spherical spheres is given as

$$12R - 3R = 9R$$



As the bodies move under mutual forces, the centre of mass will remain stationary.

So, we get

$$m_1x_1 = m_2x_2$$

$$Mx = 5M(9R - x)$$

$$x = 45R - 5x$$

4x

$$x = 6R$$

15. From the Wien's displacement law, we have  $\lambda_m \propto$

$T^{-1}$  Thus, according to the sequence of the spectrum  $(\lambda_m)_P < (\lambda_m)_R < (\lambda_m)_Q$   
So,  $T_P > T_R > T_Q$

16.  $1.0 \times 10^{-2}$

Bulk modulus is  $\beta = \frac{pV}{\Delta V}$

So,  $\frac{\Delta V}{V} = \frac{p}{\beta}$  .....(1)

Now,  $p = \rho gh$  and compressibility,  $K = \frac{1}{\beta}$

Substituting in equation (1), we

$$\begin{aligned} \frac{\Delta V}{V} &= \rho gh \times K \\ &= 10^3 \times 9.8 \times 2700 \times 45.4 \times 10^{-11} \\ &= 1.2 \times 10^{-2} \end{aligned}$$

Thus, the fractional compression of the water at the bottom of the ocean is  $1.2 \times 10^{-2}$ .

17. 4.0 J/s

The rate of conduction of heat is directly proportional to the temperature difference. That is, we have

$$\frac{dQ}{dt} \propto T_2 - T_1$$

The temperature difference between the two ends of the rod is the same, i.e.  $10^\circ\text{C}$  in both cases.

Hence, the rate of heat flow will also be the same. So, we have

$$\frac{dQ}{dt} = 4.0 \text{ J/s}$$

18.  $2.4 \times 10^5$  N, downwards

Let  $P_1$  and  $P_2$  be the pressure and  $V_1$  and  $V_2$  be the velocity of the wind inside and outside the roof of the house, respectively.

Here,  $V_2 = 40$  m/s,  $V_1 = 0$  and  $\rho = 1.2$  kg/m<sup>3</sup>

According to the Bernoulli's theorem,

$$P_1 + \frac{1}{2} \rho V_1^2 = P_2 + \frac{1}{2} \rho V_2^2$$

$$P_1 + 0 = P_2 + \frac{1}{2} \rho V_2^2$$

$$P_1 - P_2 = \frac{1}{2} \rho V_2^2$$

$$\rightarrow \text{Pressure difference} = \Delta P = \frac{1}{2} \rho V_2^2$$

$$\Delta P = \frac{1}{2} \times 1.2 \times (40)^2 = 960$$

We know that force,  $F = \Delta P \times A$

$$F = 960 \times 250$$

$$= 2.4 \times 10^5 \text{ N}$$

As  $V_2 > V_1 \Rightarrow P_2 < P_1$ , the force will be in the upward direction.

19. 460 J

For a cyclic process  $\Delta U = 0$

Total heat absorbed by the system during the cyclic process = Work done during the cyclic process ABCA

$$Q_{ABCA} = W_{ABCA}$$

i.e:

$Q_{AB} + Q_{BC} + Q_{CA} = \text{Area of the curve representing the process}$  Given that:

$$Q_{AB} = 400 \text{ J}$$

$$Q_{BC} = 100 \text{ J}$$

$400 \text{ J} + 100 \text{ J} + Q_{CA} = \text{Area of the curve representing the process}$

$$500 \text{ J} + Q_{CA} = \frac{1}{2} \times BC \times AB$$

$$500 \text{ J} + Q_{CA} = \frac{1}{2} \times (4 \times 10^{-3} - 2 \times 10^{-3}) \times (6 \times 10^4 - 2 \times 10^4)$$

$$500 \text{ J} + Q_{CA} = \frac{1}{2} \times (2 \times 10^{-3}) \times (4 \times 10^4)$$

$$500 \text{ J} - Q_{AC} = 40$$

$$Q_{AC} = 460 \text{ J}$$

20. 90 J

The coefficient of performance of a refrigerator is given by  $\beta = \frac{Q_2}{W}$

where  $Q_2$  is the amount of heat drawn from the sink (reservoir at lower temperature) and  $W$  is the work done on the system.

Again we have that  $\beta = \frac{1}{1-\eta}$ ,  $\eta$  being the efficiency of the Carnot engine

$$\Rightarrow \frac{1-\eta}{\eta} = \frac{Q_2}{W}$$

$$\Rightarrow Q_2 = W \left( \frac{1-\eta}{\eta} \right)$$

Given that  $\eta = \frac{1}{10}$  and  $W = 10 \text{ J}$

$$\Rightarrow Q_2 = 10 \times \left( \frac{1 - \frac{1}{10}}{\frac{1}{10}} \right)$$

$$\Rightarrow Q_2 = 90 \text{ J}$$

21. -20 kJ

The change in internal energy of gas is given by  $\Delta U = nC_v \Delta T$  ..... (1)

But we know that  $C_v = \frac{R}{\gamma - 1}$  ..... (2)

From the ideal gas equation,  $PV = nRT$

$$T = \frac{PV}{nR}$$

$$\Delta T = T_2 - T_1 = \frac{P_2 V_2 - P_1 V_1}{nR}$$
 ..... (3)

Substituting (2) and (3) in (1) we get:

$$\Delta U = n \times \frac{R}{\gamma - 1} \times \frac{P_2 V_2 - P_1 V_1}{nR}$$

$$\Delta U = \frac{P_2 V_2 - P_1 V_1}{\gamma - 1}$$

$$\Delta U = \frac{(5 \times 10^3) \times 6 - (2 \times 10^3) \times 4}{\gamma - 1}$$

$$\Delta U = \frac{(2 \times 10^3) \times 6 - (5 \times 10^3) \times 4}{2/5}$$

$$\Delta U = \frac{-8 \times 10^3}{2/5}$$

$$\Delta U = -20 \text{ kJ}$$

$$22. 1 + n^2$$

We know that  $\gamma = \frac{C_p}{C_v}$

$$\text{But } C_p = \left( \frac{n}{2} + 1 \right) R$$

$$\text{and } C_v = \left( \frac{n}{2} \right) R$$

Therefore:

$$\frac{\left( \frac{n}{2} + 1 \right) R}{\left( \frac{n}{2} \right) R}$$

$$\Rightarrow \gamma = \frac{n}{n-2} = 1 + n^2$$

23. Simple harmonic with amplitude  $\sqrt{a^2 + b^2}$

Given:

$$y_1 = a \sin \omega t$$

$$y_2 = b \cos \omega t$$

$$y_2 \text{ can also be written as: } y_2 = b \sin \left( \omega t + 2\frac{\pi}{2} \right)$$

Both SHM have the same frequency; hence, the resultant motion will also be SHM.

The amplitude of the resultant motion,  $A = \sqrt{a_1^2 + a_2^2 + 2a_1a_2 \cos \phi}$

$$A = \sqrt{a^2 + b^2 + 2ab \cos \phi}$$

$$\text{But } \phi = 2\frac{\pi}{2}$$

Therefore:

$$A = \sqrt{a^2 + b^2}$$

Therefore, the resultant motion will be simple harmonic with amplitude  $\sqrt{a^2 + b^2}$ .

$$24. T = 2\pi \sqrt{\frac{x_2^2 - x_1^2}{v_2^2 - v_1^2}}$$

The velocity of a particle executing SHM is given by  $v = \omega \sqrt{a^2 - y^2}$  where  $a$  is the amplitude of simple harmonic motion,  $\omega$  its angular frequency and  $y$  is the displacement from the mean position.

Here, the velocities of the particle can be written as

$$V_1 = \omega \sqrt{a^2 - x_1^2}$$

and

$$V_2 = \omega \sqrt{a^2 - x_2^2}$$

On squaring the above two equations:

$$V_1^2 = \omega^2 (a^2 - x_1^2) \text{ and } V_2^2 = \omega^2 (a^2 - x_2^2)$$

$$V_1^2 = \omega^2 a^2 - \omega^2 x_1^2 \text{ -----(1)}$$

$$V_2^2 = \omega^2 a^2 - \omega^2 x_2^2 \text{ -----(2)}$$

$$V_1^2 - V_2^2 = -\omega^2 x_2^2 + \omega^2 x_1^2$$

$$V_1^2 - V_2^2 = \omega^2 x_1^2 - \omega^2 x_2^2$$

$$\frac{V_1^2 - V_2^2}{x_1^2 - x_2^2} = \omega^2$$

$$\omega = \sqrt{\frac{V_1^2 - V_2^2}{x_1^2 - x_2^2}} \text{ -----(3)}$$

$$\text{But angular frequency } \omega = \frac{2\pi}{T} \text{ ----(4)}$$

$$\sqrt{\frac{V_1^2 - V_2^2}{x_1^2 - x_2^2}} = \frac{2\pi}{T}$$

$$\text{Therefore timeperiod, } T = 2\pi \sqrt{\frac{x_2^2 - x_1^2}{V_2^2 - V_1^2}}$$

25. 120 cm

Given: Length of the closed organ pipe,  $L_c = 20$  cm

Let the length of the organ pipe open at both ends be  $L_o$ .

The fundamental frequency of a closed organ pipe is given by:  $\frac{v}{4L_c}$

The second overtone of an organ pipe open at both ends is given by:  $\frac{3v}{2L_o}$

$$\frac{v}{4L_c} = \frac{3v}{2L_o}$$

$$L_o = \frac{3 \times 4L_c}{2}$$

$$L_o = 6L_c$$

$$L_o = 6 \times 20$$

$$L_o = 120 \text{ cm}$$

26. The charge on the capacitor is not conserved. On

charging, the charge of the capacitor,  $Q = CV$ .

But the charge remains constant even after disconnecting the capacitor from the cell.

Thus, we can say that the charge on the capacitor is conserved.

The energy stored in the capacitor when connected to cell of emf  $V$ ,  $U_i = \frac{1}{2}CV^2$

When a dielectric slab is placed in between:

The capacity of the capacitor increase, i.e  $C' = KC$

The potential  $V$  decreases as,  $V' = \frac{V}{K}$

Energy stored in the capacitor decreases.

Then the energy stored becomes,  $U_f = \frac{1}{2}C'V'^2 =$

$$U_f = \frac{1}{2}KC \left( \frac{V}{K} \right)^2$$

$$U_f - U_i = \frac{1}{2}KC \left( \frac{V}{K} \right)^2 - \frac{1}{2}CV^2$$

$$\Delta U = \frac{1}{2}CV^2 \left( \frac{1}{K} - 1 \right)$$

27.  $4\pi\epsilon_0 Aa^3$

Electric flux linked with a sphere will be  $\phi = \vec{E} \cdot \vec{ds}$

Given  $E = A r$

As the electric field is acting radially outwards, we get that:

$$\phi = E ds$$

$$\phi = Ar 4\pi r^2$$

$$\phi = Aa 4\pi a^2$$

$$\phi = A4\pi a^3$$

According to gauss law:

The electric flux over a closed surface,  $\phi = \frac{q}{\epsilon_0}$

$$A4\pi a^3 = \frac{q}{\epsilon_0}$$

$$\Rightarrow q = A4\pi a^3 \epsilon_0$$

$$q = 4\pi\epsilon_0 Aa^3$$

28.  $32 \Omega$

$$\frac{\text{mV}}{\text{cm}} = \frac{10^{-3} \text{ volt}}{10^{-2} \text{ m}} = \frac{\text{Volt}}{\text{m}}$$

Potential gradient  $(x) = 1 \text{ cm} = 10^{-2} \text{ m} = 0.1 \text{ m}$

$$x = \frac{E}{R + R'} \times \frac{R}{L}$$

$$0.1 = \frac{2}{8 + R'} \times \frac{8}{4}$$

$$8 + R' = 40$$

$$R' = 32 \Omega$$

29.  $V_A = V_B = V_C$

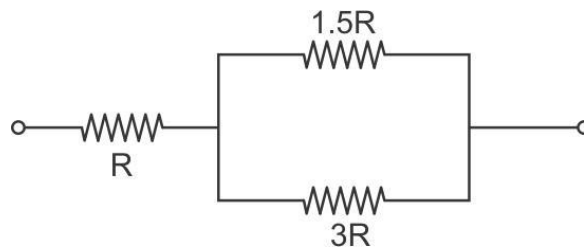

B and C are in parallel combination, so the potential is the same.

$$\therefore V_B = V_C$$

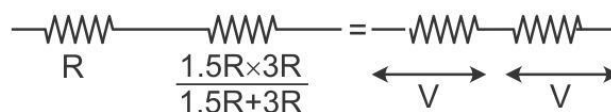



$$\text{Effective resistance of B and C} = \frac{1.5 \times 3R}{1.5R + 3R}$$

In a series connection,  $V \propto R$ , so the voltage across A = voltage across B and C  $\therefore V_A = V_B = V_C$

### 30. Current

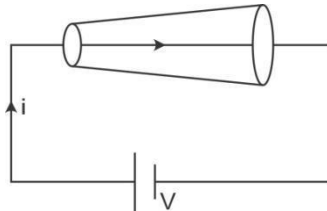

With the exception of current, the values of all other quantities depend on the area of cross-section of the conductor. Hence, only current remains constant when it flows through a conductor of non-uniform area of cross-section.

$$31. \vec{B} = -\frac{\mu}{4\pi R} \pi I (\pi \hat{i} + 2 \hat{k})$$

Let B be the magnetic field at point O and  $B_L$  be the magnetic field because of the straight wires.

The magnetic field due to a straight current carrying wire is given by

$$\vec{B}_L = \frac{\mu}{4\pi R} I (\sin \phi_1 + \sin \phi_2)$$

Here we have two straight wires (linear part of the wire) parallel to x-axis

$$\text{Therefore, } B_L = 2 \times \left[ \frac{\mu I}{4\pi R} (\sin \phi_1 + \sin \phi_2) \right]$$

$$\vec{B}_L = 2 \times \left[ \frac{\mu_0 I}{4\pi R} (\sin 90 + \sin 0) \right] (-\hat{k})$$

$$\vec{B}_L = 2 \times \left[ \frac{\mu_0 I}{4\pi R} \right] (-\hat{k})$$

$$\text{Magnetic field due to the semi-circular portion will be, } B_s = \frac{1}{2} \left[ \frac{\mu_0 I}{2R} \right] (-\hat{i})$$

Net magnetic field,  $\vec{B} = \vec{B}_L + \vec{B}_s$

$$\vec{B} = 2 \times \left[ \frac{\mu_0 I}{4\pi R} \right] (-\hat{k}) + \frac{1}{2} \left[ \frac{\mu_0 I}{2R} \right] (-\hat{i})$$

$$\vec{B} = - \left[ \frac{\mu_0 I}{2\pi R} \right] \hat{k} - \left[ \frac{\mu_0 I \pi}{4\pi R} \right] \hat{i}$$

$$\vec{B} = - \left[ \frac{\mu_0 I}{4\pi R} \right] 2\hat{k} - \left[ \frac{\mu_0 I \pi}{4\pi R} \right] \hat{i}$$

$$\vec{B} = - \frac{\mu_0 I}{4\pi R} (\pi \hat{i} + 2 \hat{k})$$

32.  $\frac{\mu_0 n e}{2r}$

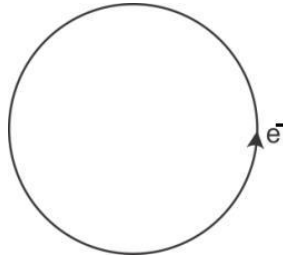

Magnetic field induction B at the centre of a current-carrying coil is

$$B = \frac{\mu_0 n I}{2r}$$

where  $I = ne$

$$B = \frac{\mu_0 n (ne)}{2r} = \frac{\mu_0 n^2 e}{2r}$$

33.  $\frac{1}{(2x - a)(2x + a)}$

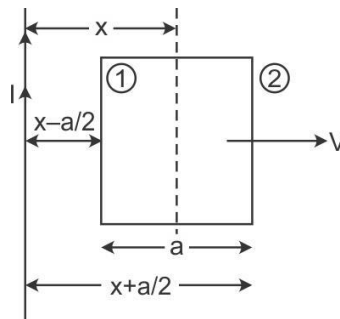

The emf induced in the side (1) is given as  $\epsilon_1 = B_1 vl$

The emf induced in the side (2) is given as  $\epsilon_2 = B_2 vl$

Thus, the emf induced in the frame is given as

$$\epsilon = \epsilon_1 - \epsilon_2$$

$$\epsilon = B_1 vl - B_2 vl$$

$$\epsilon = vl (B_1 - B_2)$$

$$\epsilon \propto (B_1 - B_2)$$

But  $B \propto \frac{1}{r}$

So,  $\Rightarrow \epsilon \propto \frac{1}{r}$

$$\Rightarrow \epsilon \propto \left[ \frac{1}{x - \frac{a}{2}} - \frac{1}{x + \frac{a}{2}} \right]$$

$$\Rightarrow \epsilon \propto \frac{1}{(2x - a)(2x + a)}$$

$$34. P = \left( \frac{R}{Z} \right)^2$$

Power is given as

$$P = E_m I_m$$

$$P = \frac{E_m^2}{R}$$

$$P' = E_m I_m \cos \phi$$

$$P' = E_m \frac{E_m}{Z} \times \frac{R}{Z}$$

$$P' = (E_m)^2 \times \frac{R}{Z^2}$$

$$\frac{P'}{P} = \frac{(E_m)^2}{R} \times \frac{Z^2}{R(E_m)^2}$$

$$\frac{P'}{P} = \frac{Z^2}{R^2}$$

$$P' = \frac{R^2}{Z^2} P$$

$$P' = \left( \frac{R}{Z} \right)^2 P$$

$$35. \frac{2E}{C}$$

Momentum transferred to the surface is given as

$$\Delta P = \frac{2I}{C} = \frac{2E}{C}$$

36. -50 cm

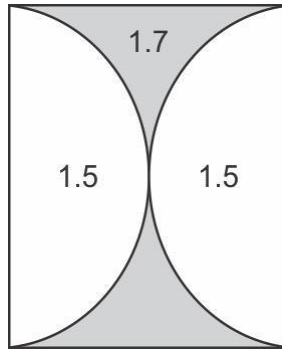

$$\frac{1}{f} = \frac{1}{f_1} + \frac{1}{f_2} + \frac{1}{f_3}$$

By using lens maker formula,

$$\frac{1}{f} = (\mu_3 - 1) \left( \frac{1}{R_1} - \frac{1}{R_2} \right)$$

$$\begin{aligned} \frac{1}{f_1} &= (1.5 - 1) \left( \frac{1}{20} - \frac{1}{\infty} \right) \\ &= 0.5 \left( \frac{1}{20} \right) = \frac{1}{40} \text{ cm}^{-1} \end{aligned}$$

$$\begin{aligned} \frac{1}{f_2} &= (1.7 - 1) \left( \frac{1}{20} - \frac{1}{20} \right) \\ &= 0.7 \left( \frac{-40}{400} \right) = 0.7 \left( \frac{-1}{10} \right) \\ &= -\frac{0.7}{10} = -\frac{7}{100} \text{ cm}^{-1} \end{aligned}$$

$$\begin{aligned} \frac{1}{f_3} &= (1.5 - 1) \left( \frac{1}{20} - \frac{1}{\infty} \right) \\ &= 0.5 \left( \frac{1}{20} \right) = \frac{1}{40} \text{ cm}^{-1} \end{aligned}$$

Focal length of combination

$$\begin{aligned} \frac{1}{f} &= \frac{1}{40} - \frac{7}{100} + \frac{1}{40} \\ &= \frac{5 - 14 + 5}{200} = \frac{-4}{200} \\ &= -\frac{1}{50} \text{ cm}^{-1} \end{aligned}$$

37.  $\frac{2D\lambda}{a}$

For a single slit diffraction obtained on a screen, the width of the central maxima is

given as  $\frac{2D\lambda}{a}$ .

Here, D is the distance from the slit to the screen,

a is the slit width and

$\lambda$  is the wavelength of light used.

38. 0.2 mm

Wavelength of light is  $\lambda = 500 \text{ nm}$

For double slit experiment:

Distance between two slits is  $d = 1 \text{ mm}$

Distance to the screen is  $D = 1 \text{ m}$

Now, the fringe width in double slit experiment is  $\frac{\lambda D}{d}$

Hence, fringe width of 10 maxima is  $10\lambda D/d$  \_\_\_\_\_

Now, for a single slit experiment with slit width a, we have the width of central maxima

as  $\frac{2\lambda D}{a}$

To fit 10 maxima within the central maxima of a single slit, we have

$$\frac{10\lambda D}{d} = \frac{2\lambda D}{a}$$

$$\therefore a = \frac{2\lambda Dd}{10\lambda D} = \frac{d}{5}$$

$$\therefore a = \frac{1}{5} = 0.2 \text{ mm}$$

### 39. $180^\circ - 2A$

The refractive index of the material of the prism is given in terms of the angle of the prism and the angle of minimum deviation as

$$\mu = \frac{\sin\left(\frac{A + \delta_m}{2}\right)}{\sin\left(\frac{A}{2}\right)}$$

It is given that  $\mu = \cot\left(\frac{A}{2}\right)$ . So substituting, we get

$$\cot\left(\frac{A}{2}\right) = \frac{\sin\left(\frac{A + \delta_m}{2}\right)}{\sin\left(\frac{A}{2}\right)}$$

$$\therefore \frac{\cos\left(\frac{A}{2}\right)}{\sin\left(\frac{A}{2}\right)} = \frac{\sin\left(\frac{A + \delta_m}{2}\right)}{\sin\left(\frac{A}{2}\right)}$$

$$\therefore \cos\left(\frac{A}{2}\right) = \sin\left(\frac{A + \delta_m}{2}\right)$$

$$\because \cos \theta = \sin(90^\circ - \theta)$$

$$\therefore \sin\left(90^\circ - \frac{A}{2}\right) = \sin\left(\frac{A + \delta_m}{2}\right)$$

$$\Rightarrow \frac{A + \delta_m}{2} = 90^\circ - \frac{A}{2}$$

$$\therefore A + \delta_m = 180^\circ -$$

$$A \therefore \delta_m = 180^\circ - 2A$$

### 40. $4\lambda$

According to Einstein's photoelectric equation, we have

$$eV_0 = \frac{hc}{\lambda} - W$$

$$\therefore V_0 = \lambda \frac{hc}{e} - \frac{W}{e}$$

So, for the light of wavelength  $\lambda$ , we get

$$3V_0 = \frac{hc}{\lambda e} - \frac{W}{e} \quad \dots\dots (1)$$

And for the light of wavelength  $2\lambda$ , we get

$$V_0 = \frac{hc}{2\lambda e} - \frac{W}{e} \quad \dots\dots (2)$$

Substituting equation (2) in (1), we get

$$\frac{3hc}{2\lambda e} - \frac{3W}{e} = \frac{hc}{\lambda e} - \frac{W}{e}$$

$$\therefore 2 \frac{3hc}{\lambda e} - \lambda \frac{hc}{e} = \frac{3W}{e} + \frac{W}{e}$$

$$\therefore \lambda \frac{hc}{e} \left( \frac{3}{2} - 1 \right) = \frac{2W}{e}$$

$$\therefore 2 \frac{hc}{\lambda e} = \frac{2W}{e}$$

$$\therefore W = 4 \frac{hc}{\lambda}$$

Now, we know that the threshold wavelength is given as

$$\lambda_0 = \frac{hc}{W}$$

41.

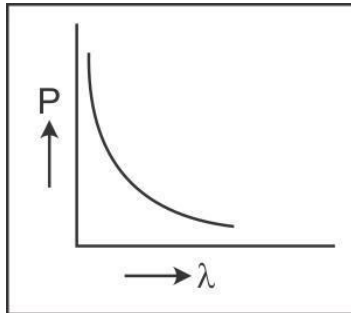

The de Broglie wavelength of a particle is given in terms of its momentum as

$$\lambda = \frac{h}{p}$$

$$\therefore \lambda \propto \frac{1}{p}$$

Hence, we see that the momentum is inversely proportional to the wavelength. So, if the wavelength increases, then the momentum decreases. Also, the graph would be similar to a hyperbola. Hence, the correct option is (2).

42.  $1.46 \times 10^6 \text{ m/s}$

The velocity of an electron in an orbit in an atom is given as

$$v_n = \frac{2\pi Ze^2}{4\pi\epsilon_0 nh} = \left( \frac{Z}{n} \right) \left( \frac{2\pi e^2}{4\pi\epsilon_0 h} \right) = \left( \frac{Z}{n} \right) \left( \frac{2\pi e^2 K}{h} \right)$$

Substituting the values in the above equation, we get

$$\begin{aligned} v &= \left( \frac{Z}{n} \right) \left( \frac{2\pi e^2 K}{h} \right) \\ &= \left( \frac{Z}{n} \right) \left( \frac{2 \times 3.14 \times (1.6 \times 10^{-19})^2 \times 9 \times 10^9}{6.6 \times 10^{-34}} \right) \\ &= \left( \frac{Z}{n} \right) \times 2.2 \times 10^6 \\ &= 2.2 \times 10^6 \times \frac{2}{3} \\ &= 1.46 \times 10^6 \text{ m/s} \end{aligned}$$

43.  $\frac{5}{3} R_{Al}$

We know that the atomic radius is directly proportional to the cube root of the atomic mass number A.

Hence, we get

$$\begin{aligned} R &\propto A^{\frac{1}{3}} \\ \therefore \frac{R_{Te}}{R_{Al}} &= \left( \frac{A_{Te}}{A_{Al}} \right)^{\frac{1}{3}} = \left( \frac{125}{27} \right)^{\frac{1}{3}} = \frac{125^{\frac{1}{3}}}{27^{\frac{1}{3}}} = \frac{5}{3} \\ \therefore R_{Te} &= \frac{5}{3} R_{Al} \end{aligned}$$

44.

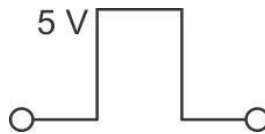

The diode allows only the positive voltage to pass through it. Hence, the circuit acts as a half-wave rectifier. Hence, the correct waveform will be as shown in the option (4).



#### 45. AND

The output of the gate is shown in the following truth table:

A	B	$Y_1 = \overline{A}$	$Y_2 = \overline{B}$	$Y = \overline{\overline{A} + \overline{B}}$
0	0	1	1	0
0	1	1	0	0
1	0	0	1	0
1	1	0	0	1

From the above truth table, one can see that it is similar to that of the AND gate.

## Chemistry

46. Structure of  $\text{XeO}_4$  is as follows:

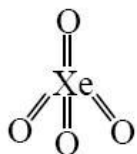

$$\sigma = 4, \pi = 4$$

In the  $\text{XeO}_4$  molecule, 4  $\sigma$  and 4  $\pi$  bonds are present.

47.  $\text{Ca}^{2+} < \text{K}^+ < \text{Ar}$

$$\text{Size} \propto \frac{1}{\text{Effective nuclear charge}}$$

48. Ionic equilibrium in intracellular and extracellular fluids is maintained by  $\text{Na}^+/\text{K}^+$  pumps in the plasma membrane of the cells.

49. All nitrates are highly soluble in water because of which their minerals do not exist in the Earth's crust.

50. Solubility is directly proportional to the lattice energy and hydration energy. Lattice energy and hydration energy decrease down the group, so solubility of II A sulphate decreases down the group.

51. Zr and Hf have nearly the same atomic radii because of lanthanoid contraction.

52. In the oxidation of  $\text{Fe}(\text{CO})_5$  from Fe, the oxidation state of iron remains the same.

53.  $\text{ClO}_3^-$  and  $\text{SO}_3^{2-}$  both have  $sp^3$  hybridisation and both contain the same number of electrons, i.e. 42.

54. Bond order  $O_2^- < O_2 < O_2^+$   
 $O_2^+ \quad 1.5 \quad 2 \quad 2.5$

55. Sulphur dioxide is used as a preservative.

56.  $NO_2^+ > NO_2 > NO_3^- > NO_2^-$   
 $180^\circ \quad 132^\circ \quad 120^\circ \quad 120^\circ$

57.

$$\mu = \sqrt{n(n+2)}$$

$$2.84 = \sqrt{n(n+2)}$$

$$(2.84)^2 = n(n+2)$$

$$n^2 + 2n - 8.0656 = 0$$

Solving the above quadratic equation, we get

$$n = 2$$

That means the number of unpaired electrons = 2

Electronic configuration of  $Ni^{2+} = [Ar]3d^84s^0$



58.  $CoCl_3 \cdot 3NH_3 \rightarrow [Co(NH_3)_3Cl_3] [Co(NH_3)_3Cl_3]$   
 $[Co(NH_3)_3Cl_3] \xrightarrow{AgNO_3} \text{no ppt}$

59.  $[Co(CN)_6]^{3-}$

$Co^{3+}: 1s^2 2s^2 2p^6 3s^2 3p^6 4s^0 3d^6$

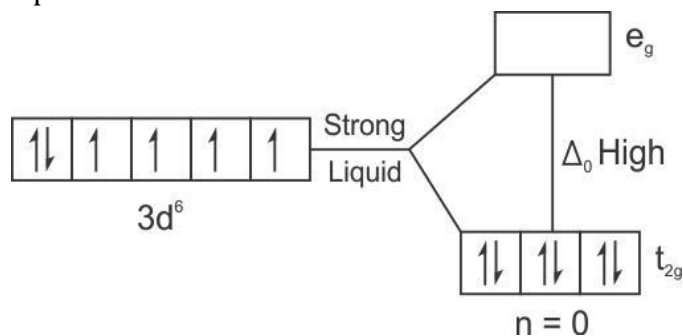

Thus,  $Co^{3+}$  in the compound  $[Co(CN)_6]^{3-}$  does not contain any unpaired electrons and hence will be in a low-spin configuration.

60. The activation energy of a reaction can be determined from the slope of the graph  $\log K$  versus  $1/T$  according to Arrhenius theory.

61. According to the condition for an ideal solution,  $\Delta S_{\text{mix}} \neq 0$

62. Given:

The ratio of the weights of the gases  $\text{H}_2$  and  $\text{O}_2$  are 1:4 (w/w)

Solution:

Molar masses of  $\text{H}_2$  and  $\text{O}_2$  are 4 and 32, respectively.

Hence, the mole ratio is as follows:

$$\begin{array}{l} \text{H}_2 : \text{O}_2 \\ \text{Mole ratio} \quad \frac{1}{2} : \frac{4}{32} \\ \quad \quad \quad \frac{1}{2} : \frac{1}{8} \\ \quad \quad \quad \frac{4}{8} : \frac{1}{8} \\ \quad \quad \quad 4 : 1 \end{array}$$

63. Given:

4 metal atoms per unit cell  
cell Edge length 361 pm

Solution:

$Z = 4$  for FCC unit cell

$$r = \frac{a}{2\sqrt{2}} = \frac{361}{2\sqrt{2}}$$

$$r = 127.6 \text{ pm}$$

64. Half-life or  $t_{1/2} = \frac{0.693}{k}$  is independent of the concentration of the reactant.

65. For a reaction:

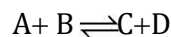

$$K_c = \frac{[\text{C}][\text{D}]}{[\text{A}][\text{B}]}$$

The value of  $K_c$  will be high if the numerator which contains the concentration of products is high. In the given example, the value of equilibrium constant is very high. Hence, the products are mostly present.

66. Galvanic cells which are designed to convert the energy of combustion of fuels such as hydrogen, methane, methanol etc. directly into electrical energy are called fuel cells.

67. Elevation in boiling point,  $(\Delta T_b)_{\text{observed}} = i K_b m = i (\Delta T_b)_{\text{theoretical}}$

But molality is the same; hence,  $(\Delta T_b)_{\text{observed}}$  will depend on van't Hoff factor, which means colligative property. If the boiling point of the solution containing X solute increases, then it must be undergoing dissociation in water.

68. For 100% ionisation or complete dissociation of solute, van't Hoff factor  $i =$  number of particles. For  $\text{Al}_2(\text{SO}_4)_3$ ,  $i = 5$ .

From the options,  $i = 5$  is for  $\text{K}_4[\text{Fe}(\text{CN})_6]$ .

69.  $\text{Fe}^{2+}$ :  $[\text{Ar}] 3d^6$  No. of  $d e^-$  is = 6

		Electronic configuration	Number of electrons
(1)	Mg (Z = 12)	$1s^2 2s^2 2p^6 3s^2$	No. of $s e^- = 6$
(2)	Cl (Z = 17)	$1s^2 2s^2 2p^6 3s^2 3p^5$	No. of $p e^- = 11$
(3)	Fe (Z = 26)	$[\text{Ar}] 3d^6 4s^2$	No. of $d e^- = 6$
(4)	Ne (Z = 10)	$1s^2 2s^2 2p^6$	No. of $p e^- = 6$

Hence, the number of d electrons in  $\text{Fe}^{2+}$  is not equal to Cl p  $e^-$ s.

70.  $\text{O}_2^{2+}$ :  $\sigma 1s^2 \sigma^* 1s^2 \sigma 2s^2 \sigma^* 2s^2$

$\sigma 2p_z^2 (\pi 2p_x^2 = \pi 2p_y^2)$

bond order:  $\frac{6-0}{2} = 3.0$

$\text{O}_2^+$ :  $\sigma 1s^2 \sigma^* 1s^2 \sigma 2s^2 \sigma^* 2s^2$

$\sigma 2p_z^2 (\pi 2p_x^2 = \pi 2p_y^2) (\pi^* 2p_x^1$

$= \pi^* 2p_y^1)$  bond order:  $\frac{6-1}{2} = 2.5$

$\text{O}_2^-$ :  $\sigma 1s^2 \sigma^* 1s^2 \sigma 2s^2 \sigma^* 2s^2$

$\sigma 2p_z^2 (\pi 2p_x^2 = \pi 2p_y^2) (\pi^* 2p_x^2$

$= \pi^* 2p_y^1)$  bond order:  $\frac{6-3}{2} = 1.5$

Hence, the correct bond order is  $\text{O}_2^- < \text{O}_2^+ < \text{O}_2^{2+}$ .

71. Angular momentum =  $\sqrt{l(l+1)} \times \hbar$   
 For orbital  $l = 2$   

$$= \sqrt{2(2+1)} \times \hbar$$

$$= \sqrt{6} \hbar$$

72. A salt with high solubility will get precipitated very late.  $\text{Ag}_2\text{CrO}_4$  is A<sub>2</sub>B type salt.

$$K_{sp} = 4s^3 = 1.1 \times 10^{-12}$$

$$\therefore s^3 = \frac{1.1}{4} \times 10^{-12}$$

$$s_1 = (0.275 \times 10^{-12})^{1/3}$$

$$s_1 = (275 \times 10^{-15})^{1/3}$$

$$s_1 = 6.5 \times 10^{-5}$$

$$\text{For AgCl, } K_{sp} = s^2 = 1.8 \times 10^{-10}$$

$$\therefore s_2 = 1.3 \times 10^{-5}$$

$$\text{For AgBr, } K_{sp} = s^2 = 5 \times 10^{-13}$$

$$s_3 = (50 \times 10^{-14})^{1/2} = 7 \times 10^{-7}$$

$$\text{For AgI, } K_{sp} = s^2 = 8.3 \times 10^{-17}$$

$$s_3 = (83 \times 10^{-18})^{1/2} = 9 \times 10^{-9}$$

Hence, the answer is  $\text{Ag}_2\text{CrO}_4$ .

73. Tyndall effect is the property of a colloidal solution which is independent of charge on the colloidal particles.

74. Gibbs energy for a reaction in which all reactants and products are in the standard state,  $rG^\circ$ , is related to the equilibrium constant of the reaction as follows:

$$0 = rG^\circ + RT \ln K$$

$$\text{or } rG^\circ = -RT \ln K$$

$$\text{or } rG^\circ = -2.303 RT \log K$$

75. Bithionol is added to soaps to impart antiseptic properties.

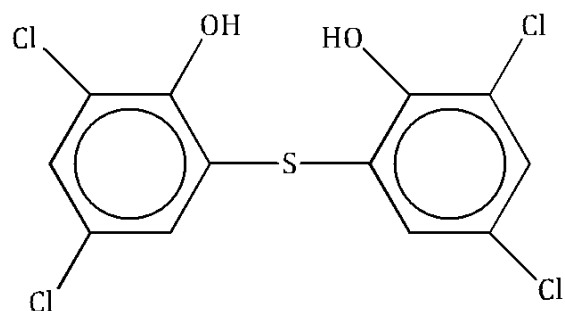

Bithionol

76. The electrolytic reduction of nitrobenzene in strongly acidic medium produces p-aminophenol.

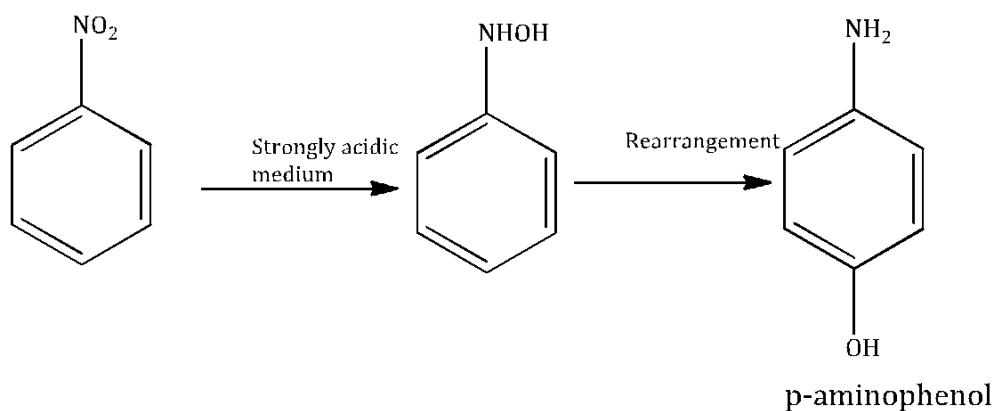

77.  $V_1 = 40$  ml

$T_1 = 300$  K

$P_1 = 725 - 25 = 700$  mm of Hg

Mass of organic compound = 0.25 g

Now using,

$$\frac{P_1 V_1}{T_1} = \frac{P_2 V_2}{T_2}$$

$$V = \frac{700 \times 40 \times 273}{300 \times 760} = 33.52 \text{ ml}$$

$$\% \text{ of N} = \frac{28 \times V \times 100}{22400 \times \text{mass of organic compound}}$$

$$\% \text{ of N} = \frac{28 \times 33.52 \times 100}{22400 \times 0.25} = 16.76$$

78.

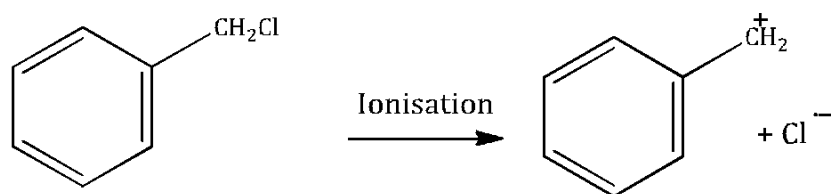

Benzyl carbonium ion

It is most stable because of resonance.

79.

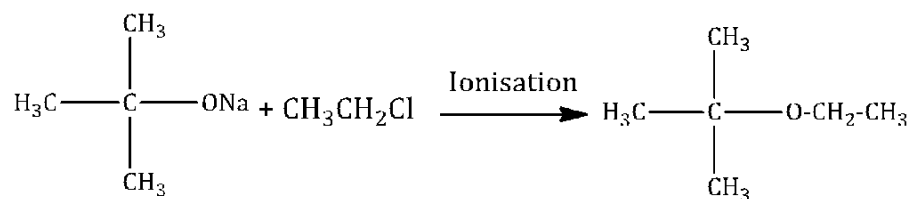

The reaction is Williamson's synthesis which is employed in the preparation of ethers.

80.

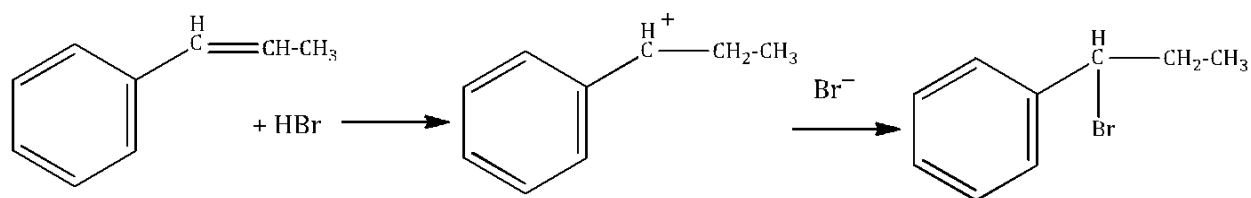

81.

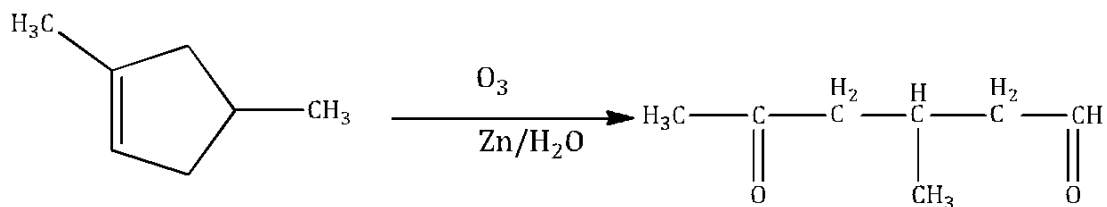

82.

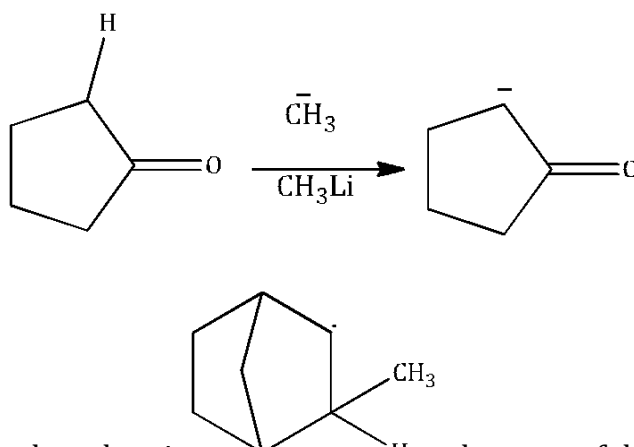

83. Hyperconjugation takes place in  because of the presence of  $\alpha$ -H.

84. Because Cl shows -I effect and CH<sub>3</sub> group shows +I effect.

85. The enolic form of ethyl acetoacetate has 18 sigma bonds and 2 pi-bonds.

86.

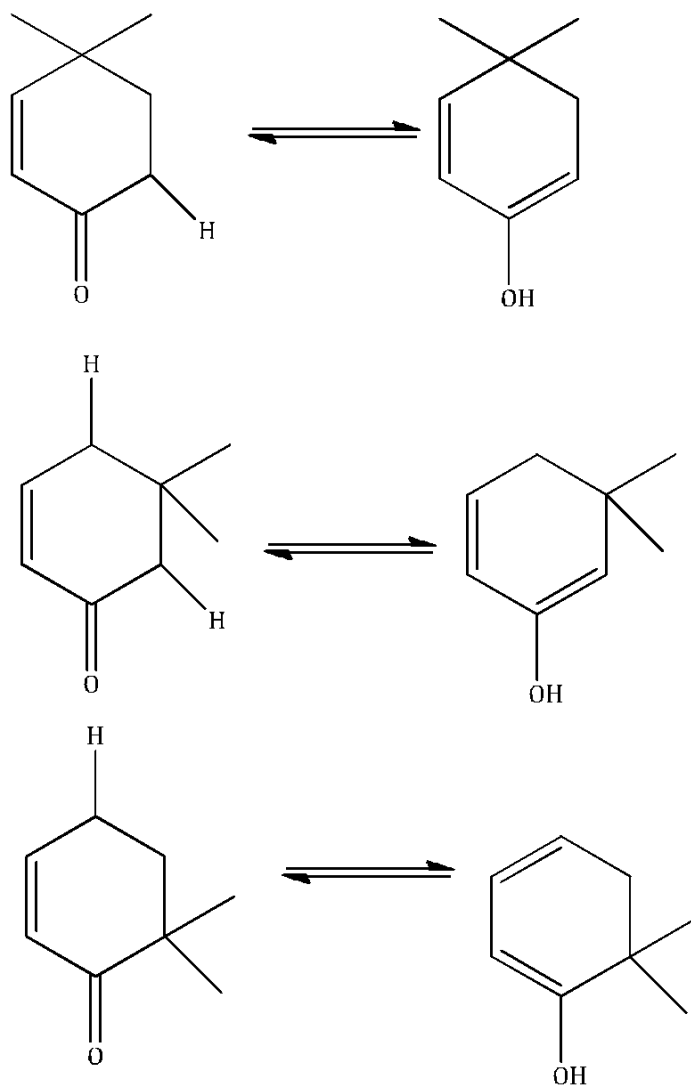

All the three compounds exhibit tautomerism.

87.

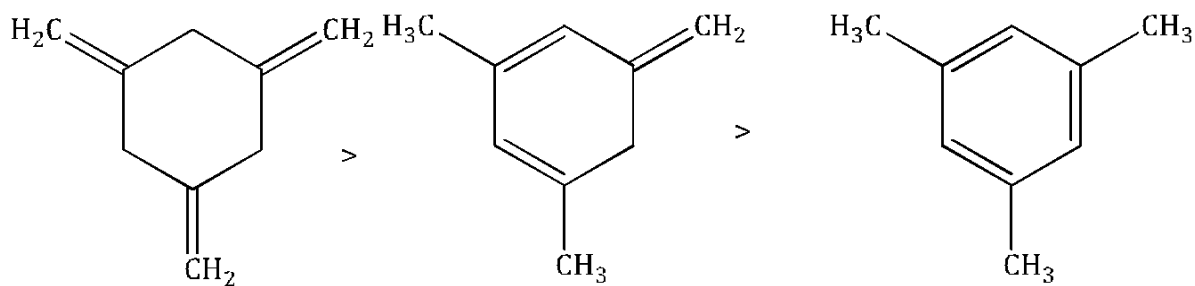

The enthalpy of hydrogenation  $\propto 1/\text{Stability}$





## Biology

91. *Phytophthora* belongs to Phycomycetes; its mycelium is aseptate.  
*Mucor* belongs to Zygomycetes; it reproduces by conjugation.  
*Agaricus* belongs to Basidiomycetes; it is saprotrophic.
92. Correct statement in case of (B): *Selaginella* is a heterosporous pteridophyte. It produces microspores and megaspores.  
Correct statement in case of (C): Coralloid roots of *Cycas* have cyanobacteria. *Nostoc* and *Anabaena* are present in the cortical region of the roots.
93. *Funaria* and *Marchantia* are bryophytes, and *Pteris* is a pteridophyte. In bryophytes and pteridophytes, the gametophyte is independent. *Pinus* is a gymnosperm; here the sporophyte is independent.
94. Mannitol is stored food in Phaeophyceae (brown algae). In Rhodophyceae (red algae), the food is stored in the form of floridean starch.
95. Methanobacilli present in the gut of cows and buffaloes are responsible for the partial digestion of cellulose.
96. *Polysiphonia* is a red alga which produces non-motile or non-flagellated male gametes. *Anabaena* reproduces either by vegetative reproduction or by asexual reproduction by the formation of spores.  
*Ectocarpus* is a brown alga. The male gametes are motile with the presence of two unequal flagella.  
*Spirogyra* exhibits isogamous type of sexual reproduction in which both male and female gametes are non-motile.
97. In monocotyledons, the vascular bundle is of conjoint collateral type. Xylem and phloem combine in the same bundle and the xylem is on the inner side of the bundle. When there is no cambium present between the xylem and phloem, it is called closed because there is no scope for secondary growth.
98. The given floral formula is of the Solanaceae family. *Petunia* belongs to the Solanaceae family.  
*Allium* belongs to the Liliaceae family, *Sesbania* belongs to the Fabaceae family and *Brassica* belongs to the Brassicaceae family.
99. Monocot roots have vascular bundles without cambium. The monocot root has radial vascular bundles, while the stem has scattered vascular bundles. In dicot stems, the cambium is sandwiched between the phloem and xylem along the radius.

**100.** The keel is a peculiar feature of vexillary aestivation. In vexillary aestivation, the largest petal, called the standard, overlaps the two lateral petals, called wings, which overlap the two smallest anterior petals called the keel. Vexillary aestivation is the distinguishing feature of the Fabaceae family. *Indigofera* belongs to the Fabaceae family.

Tomato belongs to the Solanaceae family, while Tulip and Aloe belong to the Liliaceae family. Both families exhibit valvate aestivation.

**101.** Rose is a perigynous flower, i.e.

- Gynoecium is located in the centre.
- Other whorls are located on the rim of the thalamus at the same level of the gynoecium.
- Ovary is half superior and half inferior.

Guava and cucumber have epigynous flowers; China rose is a hypogynous flower.

**102.** *Opuntia* is a xerophytic plant. To reduce the rate of transpiration, leaves in *Opuntia* are modified into spines.

**103.** In chloroplasts, there are flattened sacs called thylakoids which are stacked upon one another to form grana.

Stroma is the ground substance and stroma lamellae form bridges between different grana in the chloroplast.

Cristae are the structures present in mitochondria.

**104.** The chromosome in which the centromere is located close to one end is acrocentric. Metacentric chromosomes – The centromere is located at the median position (at the centre).

Sub-metacentric chromosome – The centromere is located slightly away from the median position.

Telocentric chromosomes – The centromere is located terminally, i.e. at one end.

**105.** Smooth ER is the site for lipid and glycogen synthesis. Rough ER is the site for protein synthesis.

**106.** *Anabaena* is a cyanobacterium; it shows the presence of nucleoid, i.e. the nuclear material is not bound by the nuclear membrane.

*Mucor* is a fungus, while *Vaucheria* and *Volvox* are algae. Fungi and algae are eukaryotes; the true nucleus is the characteristic feature of all eukaryotes.

**107.** Inclusion bodies are the non-living structures found in prokaryotes. They either store food, pigments, secretions or excretory products.

Polysomes are clusters of ribosomes attached to mRNA at the time of translation.

- 108.** Transpiration, i.e. the loss of water by aerial parts of the plants, pulls water upwards from the xylem components. Root pressure causes water to rise in plants by pushing it upwards through the xylem vessels.
- 109.** Minerals which are required by the plants in larger quantities are called macronutrients, while the minerals which are required by the plants in very small amounts are called micronutrients.  
Carbon, hydrogen, oxygen, nitrogen, sulphur, phosphorus, calcium, potassium and magnesium are macronutrients. Iron, manganese, boron, copper, zinc, molybdenum, chlorine and nickel are micronutrients.
- 110.** Auxin is one of the plant growth factors. Its synthesis occurs on the illuminated side of the plant. It is transported to the darker or shaded regions of the plants. It stimulates the growth or elongation of the cells at the shaded region which causes a plant to bend towards the source of light.
- 111.** Ring girdling is the complete removal of the strip of bark. The bark consists of cork, cork cambium and phloem. Because the phloem is removed, the sugar will not be translocated to the roots. Hence, the roots will die first.
- 112.** The sigmoid growth curve is a characteristic of living things growing in a natural environment. It is typical for all cells, tissues etc. However, the curve does not show uniformity in plants because of seasonal activity.
- 113.** Levitt proposed the active potassium transport theory. According to this theory, the stomatal opening and closing depends on the generation of a potassium ion gradient.
- 114.** Hilum is the scar on the seed where the funicle was attached. It is the scar through which the developing seeds are attached to the fruit.
- 115.** Geitonogamy is a kind of cross-pollination which is similar to autogamy because the pollen is transferred from the anther to the stigma of the same plant with the help of a pollinating agent.  
In xenogamy, pollen grains are transferred from the anther to the stigma of different plants.  
In apogamy, plants are reproduced without any fertilisation.  
In cleistogamy, plants reproduce by non-opening, self-pollinating flowers.
- 116.** Honey is the partially digested nectar which consists of minerals, sugar, enzymes and water.

- 117.** The extent of penetration of the pollen tube depends on the length of the style and passage inside the ovary. In a solid style, the pollen tube travels through the solid style by separating cells through the secretion of pectinase.  
In case of a hollow style, the pollen tube travels along the lining of the canal.
- 118.** Rhizome is an underground horizontal branching stem.  
Offsets are short stout runners terminated by a single bud.  
Bulbils are underground, lateral branches. Their ends turn up and produce buds.  
Runners are lateral branches which grow rapidly along the ground, producing buds and adventitious roots at intervals.
- 119.** Nectar and pollen grains (certain pollen grains are edible) are used by insects as food. Some flowers also offer a safe place for insects to lay their eggs.
- 120.** Mendel studied seven pairs of contrasting characters—plant height, shape of seeds, colour of seeds, colour of pods, shape of pods position of flowers, colour of flowers.
- 121.** Recombination or crossing over is the most common mechanism of genetic variation in sexually reproducing organisms. Crossing over takes place during gamete formation (meiosis).
- 122.** Micropropagation is the technique of producing thousands of plants through tissue culture. In somatic embryogenesis, embryos are developed from the somatic cells in tissue culture.
- 123.** Inversion – A part of the chromosome segment gets inverted by  $180^\circ$ , i.e. a particular order of genes of a segment of a chromosome gets reversed.  
Duplication – An extra chromosome is attached to its normal homologous chromosome so that a gene or a set of genes is represented twice in the same chromosome.  
Translocation – A separation of a chromosome segment and its union to a non-homologous chromosome.  
Crossing over – The exchange of alleles between two homologous chromosomes during meiosis I.
- 124.** Multiple alleles are present at the same locus of homologous chromosomes. Multiple alleles are more than two forms of a gene. Example: Blood
- 125.** Genetic Engineering Approval Committee (GEAC) regulates GM research and the safety of introducing GM organisms for public services.

- 126.** *Bacillus thuringiensis* forms crystals of insecticidal proteins called Cry proteins. This protein is in the inactive protoxin form. The alkaline pH of the insect gut solubilises the crystals of Cry protein and converts the protein from the inactive form to the active form.
- 127.** Crops engineered for glyphosate are resistant to herbicides. These crops can tolerate a wide range of herbicides which kill the surrounding weeds but do not provide any harm to the crops.
- 128.** Ribosomes are made of proteins and RNA.
- 129.** Polyethylene glycol and sodium nitrate are used for protoplast fusion in somatic hybridisation. This method reduces cytotoxicity and the frequency of fusion is very high.
- 130.** The UN Conference of Parties on Climate Change in 2011 was held in Durban, South Africa. During this conference, a new treaty was established to limit the emission of carbon.
- 131.** Stratification represents the vertical arrangement of the members of the community.
- 132.** *In situ* conservation strategies – National park, sacred groves, wildlife sanctuary  
*Ex situ* conservation strategies – Botanical gardens, seed banks, cryopreservation, tissue culture
- 133.** The sequential, gradual and predictable change in the species composition in an area is called succession or ecological succession. Primary succession begins in areas where no living organisms ever existed. Secondary succession begins in areas where natural biotic communities have been destroyed.  
Primary succession – Bare rock, newly created pond, newly cooled lava  
Secondary succession – Degraded forest
- 134.** Standing crop – It is the mass of living material at a trophic level at a particular time. It is commonly expressed as the number of organisms per unit area.  
Gross primary productivity – It is the rate of synthesis of organic matter by producers per unit area per unit time.  
Standing state – It is the amount of all inorganic substances present in an ecosystem per unit area at a given time.  
Net primary productivity – It is the rate of organic matter stored by the producers per unit area per unit time.

- 135.** Gross primary productivity – It is the rate of synthesis of organic matter by producers per unit area per unit time.  
Net primary productivity – It is the rate of organic matter stored by the producers per unit area per unit time.  
Secondary productivity – It is the rate of increase in energy containing biomass by consumers per unit time and area.
- 136.** Chitinous exoskeleton separates the arthropods from other segmented invertebrates. A hard exoskeleton enables arthropods to thrive in extreme conditions in the terrestrial environment.
- 137.** *Trichinella spiralis* is a roundworm. It infects different mammals including humans. The female produces eggs after mating. These eggs hatch inside the uterus, and the female lays living larvae in the small intestine of the host.
- 138.** Mammalia – Whales do not show the presence of pinna.  
Cyclostomata – Paired appendages are absent.  
Aves – Skin is dry and without glands (Exception: Presence of oil gland).
- 139.** Duck-billed platypus found in Australia is an egg-laying mammal.
- 140.** Erythropoiesis is the formation of new RBCs. It begins in human being in the embryonic stage. It first starts in the yolk sac, followed by the liver, the spleen and the red bone marrow. In adults, it takes place in the red bone marrow. The kidneys in adults release erythropoietin which stimulates erythropoiesis.
- 141.** The arthroal membrane is a thin, flexible membrane which joins the terga, sterna and pleura of the cockroach body.
- 142.** Vesicles of rough ER accumulate during telophase to re-form the nuclear envelope which was fragmented during prophase.
- 143.** Cytochromes are heme proteins which are associated with the inner mitochondrial membrane. Cytochromes play an important role in the electron transport system during cellular respiration.
- 144.** The presence of a competitive inhibitor will increase the  $K_m$  of the enzyme for the substrate; the presence of a competitive inhibitor demands more concentration of the substrate to achieve  $\frac{1}{2}V_{max}$ .

145.

I	II
(a) Synapsis aligns homologous chromosomes.	(ii) Zygotene
(b) Synthesis of RNA and proteins	(iii) G <sub>2</sub> Phase
(c) Action of enzyme recombinase	(v) Pachytene
(d) Centromeres do not separate but chromatids move towards opposite poles	(iv) Anaphase-I

146. The somatic cell is a diploid cell. S-phase indicates the replication of DNA; hence, in a diploid cell, the amount of DNA will be double after the S phase. A gamete is a haploid cell with a single set of chromosomes. So, the ratio is diploid to haploid. Because the diploid cell here is after the S phase, it will have twice the number of chromosomes and four times the amount of DNA.
147. Brunner's gland is present in the sub-mucosa of the duodenum (small intestine). It secretes an alkaline enzyme-free watery substance.
148. Gastric juice of infants contains pepsinogen, lipase and rennin. These enzymes help break down proteins and fats. Rennin hydrolyses casein of milk into paracasein.
149. Chemoreceptors present in the brain, aortic arch and carotid sinus detect the CO<sub>2</sub> and O<sub>2</sub> levels and the pH of blood. The CO<sub>2</sub> level of blood has more effect on breathing than the level of O<sub>2</sub>. Holding breath increases the concentration of CO<sub>2</sub> in the blood. Increase in the concentration of CO<sub>2</sub> in the blood causes increased breathing. Hence, holding breath beyond a point becomes impossible.
150. During the ventricular systole, the left ventricle pumps the blood into the aorta under great force and pressure. Hence, the blood pressure is maximum in the mammalian aorta during the ventricular systole.
151. Blood is a fluid connective tissue. It is made of 55% of plasma and 45% of blood cells. RBCs, WBCs and blood platelets are the blood cells.
152. The proximal convoluted tubule is involved in the obligatory reabsorption mechanism of water. Hence, if it is removed, it will affect the reabsorption of water and more water will be excreted through the urine.
153. The sliding filament theory explains the mechanism of muscle contraction. Actin filaments slide over the myosin filaments which bring about the contraction and relaxation of muscle fibres.



- 154.** The glenoid cavity is the cup-like depression present in the scapula of the pectoral girdle. It articulates with the humerus of the forelimb.  
The scapula and clavicle form the pectoral girdle. The acromion is the process present on the scapula.
- 155.** The cerebellum maintains body equilibrium and posture. Language comprehension is carried out by the temporal lobe of the cerebrum.
- 156.** The vestibule is the membranous sac-like structure present in the internal ear. It consists of the utricle and sacculus. It helps to maintain the balance, equilibrium and posture of the body. Hence, even in darkness, the gymnast is able to balance the body upside down.
- 157.** Epinephrine is secreted at the time of emergency in order to face physical stress. Its secretion is stimulated when a nerve impulse reaches the adrenal medulla through the sympathetic nervous system. The hormones act on organs supplied by the sympathetic nerve fibres and produce an effect like sympathetic stimulation. The adrenal medulla and the sympathetic system function as a closely integrated system.
- 158.** Renin is secreted by the juxtaglomerular apparatus of the kidneys which converts angiotensin to activated angiotensin II. This stimulates the increased reabsorption of sodium and water by the proximal convoluted tubules to bring the blood pressure to normal. Hence, the urine formed is concentrated.
- 159.** The changes which occur in the mammalian sperm to make it ready to fertilise the ovum is called capacitation.
- 160.** Prolactin is secreted by the anterior lobe of the pituitary gland. It stimulates breast development during pregnancy and controls the secretion of milk from the mammary glands after delivery.
- 161.** Hepatitis B virus infection, AIDS caused by human immunodeficiency virus and the ebola disease caused by the ebola virus are sexually transmitted.  
The chikungunya virus is transmitted by an infected *Aedes aegypti* mosquito.
- 162.** The germinal epithelium of seminiferous tubules gives rise to spermatogonia which are diploid sperm mother cells. Spermatogonia undergo meiosis to form haploid sperms.

- 163.** 'Hystera' is the Greek word for 'Uterus'; 'Ectomy' is the Greek word for the 'act of cutting'. Hysterectomy is the surgical removal of the uterus.  
 Prostatectomy – Surgical removal of the prostate gland  
 Vasectomy – Surgical removal of the vas deferens  
 Mastectomy – Surgical removal of the mammary glands
- 164.** Encephalitis is the inflammation of the brain. It is a viral infection.  
 Syphilis, AIDS and trichomoniasis are sexually transmitted diseases.
- 165.** An abnormal baby with 'XXX' sex chromosome is born because of an abnormal ovum with one extra 'X' chromosome, i.e. '22+XXX'. This syndrome is called an X-syndrome.
- 166.** Alleles are two different molecular forms of the same gene responsible for the same character. Alleles are present on the homologous chromosome at the same loci.
- 167.** A cross between a man with blood group 'A' and a woman with blood group 'B':

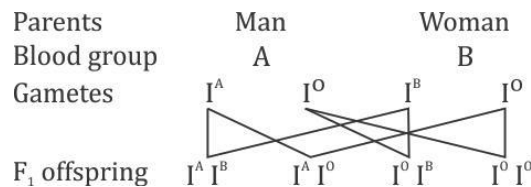

- 168.** Repressor of the lac operon is synthesised by i gene. The repressor binds to the operator region of the lac operon and prevents RNA polymerase from transcribing the operon. In the presence of lactose (inducer), the repressor is inactivated which allows RNA polymerase to continue with transcription.
- 169.** According to Chargaff's rule, for the double-stranded DNA, the ratios Adenine:Thymine and Cytosine:Guanine are constant and always equal to 1.  
 $A = T$  and  $G = C$   
 A is 17%, hence,  $T = 17\% = 1$   
 $\frac{A + T}{G + C} = 1$   
 $A + T + G + C = 100$   
 $\therefore A + T + 17 + 17 = 100$   
 $\therefore A + T = 100 - 34$   
 $\therefore A + T = 66$   
 Since,  $A = T$ ,  
 $2A = 66$   
 $A = \frac{66}{2} = 33\%$   
 $\therefore T = 33\%$

170.

Human species	Brain capacity
(1) <i>Homo erectus</i>	900 cc
(2) <i>Homo sapiens</i>	1450 cc
(3) <i>Homo neanderthalensis</i>	1400 cc
(4) <i>Homo habilis</i>	650–800 cc

171. A population will not exist in Hardy-Weinberg equilibrium if individuals mate selectively. Factors which affect the Hardy-Weinberg principle are mutation, non-random mating and genetic drift. Selective mating of individuals indicates non-random mating.

172.

Disease	Vaccine
(a) Tuberculosis	Attenuated <i>Mycobacterium tuberculae</i>
(b) Whooping cough	Killed <i>Bordetella pertussis</i> bacteria
(c) Diphtheria	Inactivated toxin of <i>Corynebacterium diphtheriae</i>
(d) Polio	Harmless (attenuated) polio virus

173. HIV first starts destroying helper T-cells. Helper T-cells play an important role in immune response. They activate B-cells for the production of antibodies and macrophages for phagocytic activities. They also control the production of cytotoxic T-cells which kill infected cells.

174. *Entamoeba histolytica* invades the colon (part of the large intestine) of the human digestive system. It attacks the mucosa and sub-mucosa of the colon and fresh RBCs.

175. Biological oxygen demand (BOD) is the amount of oxygen required for the breakdown of oxygen by microorganisms. If organic matter is more, then BOD will be high. This indicates a high amount of organic matter in water and that the water is highly polluted.

176. Stratification is complex in tropical rainforests. The vertical subdivision of a tropical rainforest is forest floor, herbs, shrubs and trees. Hence, there are more tree dwellers in the tropical rainforests.

- 177.** The graph shows the number of organisms increasing or decreasing over a period of time. Population A shows stability at the beginning, but there is a sharp decrease later, which indicates a decrease in the population. In population B, there is a gradual increase in the beginning and it accelerates later.  
In population A, the number of organisms decreased, and in population B, the number of organisms increased. Hence, population A faced tough competition from population B.
- 178.** Cryopreservation allows the storage of seeds and other parts (such as gametes) of organisms of threatened species at ultra-low temperature in liquid nitrogen. The materials can be stored for long periods in compact and low-refrigeration units.
- 179.** Rachel Carson's book 'Silent Spring' explains the entry of DDT in food chains and its effect on animals of different trophic levels.
- 180.** Depletion of stratospheric ozone leads to greater UV radiation. This may result in mutation, skin cancer, irritation and damage to eye and reduction in immunity. Causes of liver cancer are several, but ozone depletion is not one of them.